

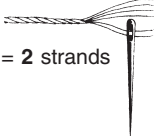











PERMIN

Scandinavian art needlework



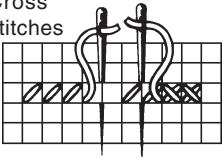

Work with split yarn = 2 strands



	947. ORANGE		415. LIGHT GREY
	352. LIGHT ROSE		310. BLACK
	321. RED		700. GREEN
	815. DARK RED	<p>Cross stitches</p> 	
	598. LIGHT TURQUOISE		
	796. DARK BLUE		
	3856. LIGHT SALMON PINK		

For this design please use Permin aida fabric. Item no. 357 in colour 22 (357/22)

1  = 1  in the fabric
Count the design from centre of fabric

Work with split yarn = 1 strand

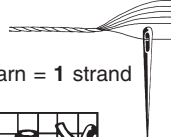

Back stitches

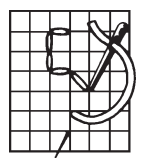

oooooo 321.
===== 815.
————— 310.

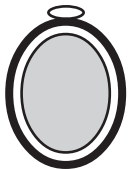

Permin no. 5961/30

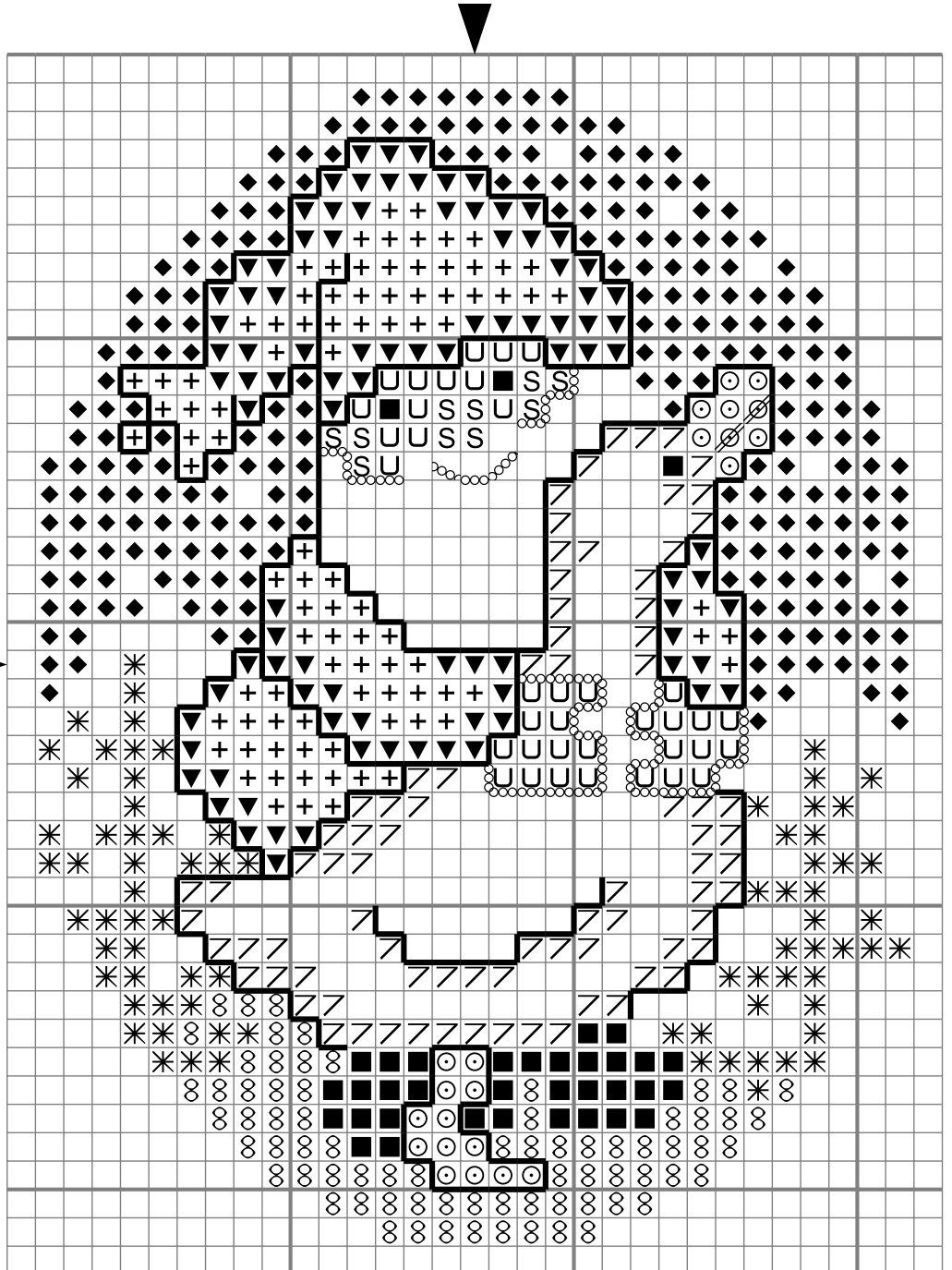

Made in Denmark©